

IR-702T

INFRARED WIRELESS TUNER

The IR-702T is a 2-channel infrared wireless tuner employing a fixed frequency system. This tuner is combined with an infrared wireless microphone and an infrared wireless receiver to make up the infrared wireless microphone system. The infrared microphone system eliminates problems with interference or eavesdropping, allowing simultaneous use in adjacent conference rooms or school classrooms.

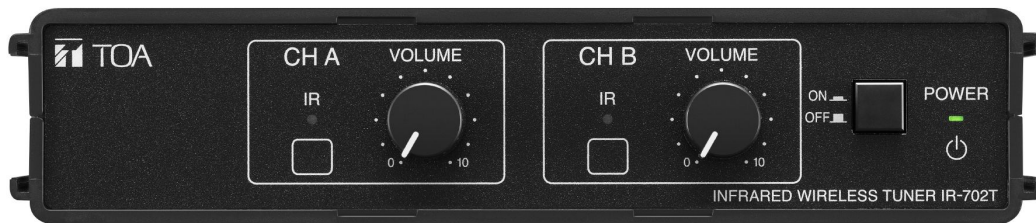

Order no: IR-702T CE

Specifications

Power source	AC mains 50/60 Hz (supplied AC adapter must be used) (max. 15 W)
Frequency response	100 Hz - 12 kHz
Receiving frequency	Channel A: 3.100 MHz / Channel B: 3.350
Receiver sensitivity	40 dB μ V input (S/N > 50 dB, \pm 4.8 kHz deviation)
Infrared receiver input	75 Ω , BNC jack x 2 (power source: 24 V DC, max. 220 mA in total of 2 terminals)
Outputs	Channel A and B: -10 dBV (\pm 4.8kHz deviation, at volume level max.), 600 Ω , electronically balanced, 3 pole phone
Connection terminal	75 Ω x 2, BNC jack
Indicator	Power, reception channel A and B
Simultaneous channels (combined)	2
S/N ratio	61 dB (60 dB μ V, \pm 4.8 kHz deviation)
Weight	630,0 g
Dimensions (W x H x D)	210 x 44 x 210,9 mm
Dimensions (ϕ x D)	x 210,9 mm
Gross weight	1,37 kg
Finish	ABS resin, black

IR-702T

INFRARED WIRELESS TUNER

Appearance

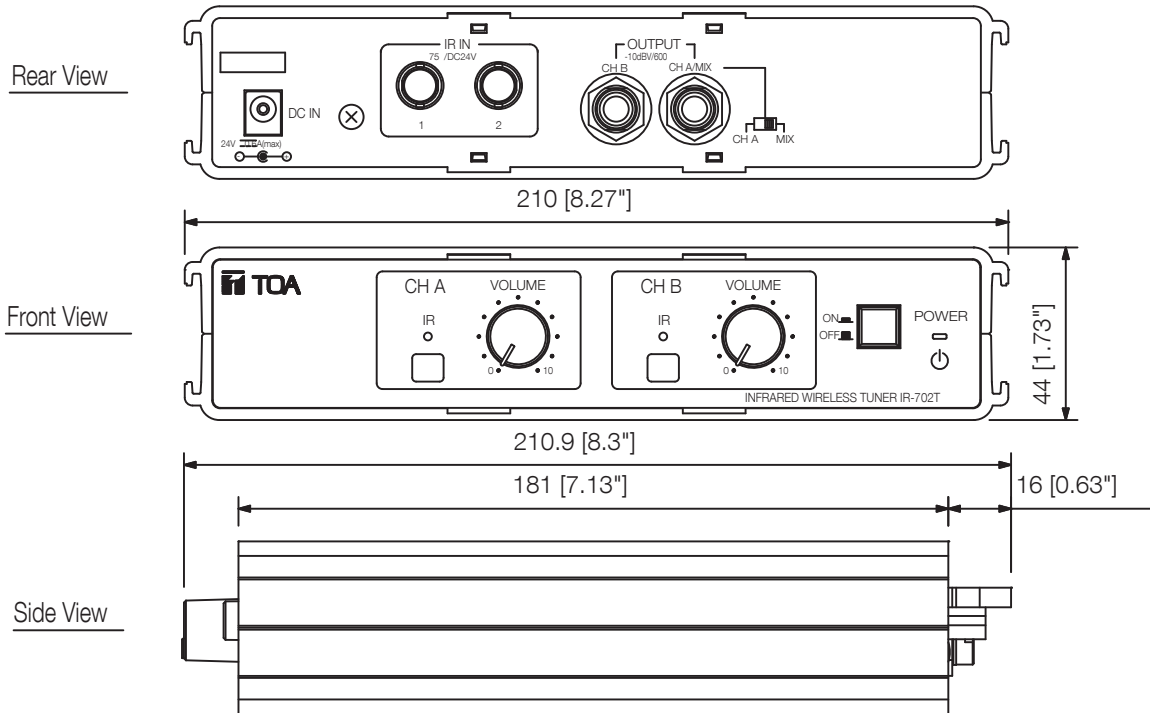

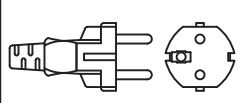
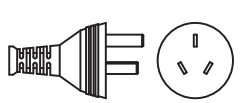
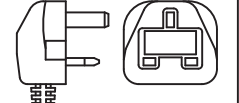
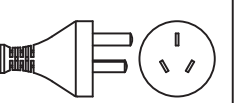
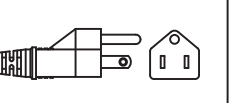
Version	CE	CE-AU	CE-GB	CN	US
AC plug					

UNIT:mm SCALE:1/2